



LEVELLING SYSTEM



Fixplus



LEVELLING SYSTEM





www.fixplus.com.tr



Fixplus

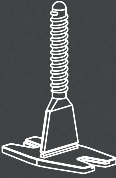

CONTENTS

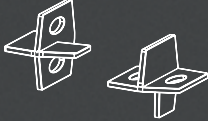
- 1 PRODUCTION 
- 2 FIXPLUS WEDGE 
- 3 FIXPLUS SCREW 
- 4 PLIER 
- 5 CROSS SPACER 



FIXPLUS LEVELLING SYSTEM

'Fixplus Levelling System' provides great convenience for tiling and ensures tiles to be set at same level.

During a tiling work, it prevents installation mistakes arising from surface deformations and accelerates the process.

'Fixplus Levelling System' can be used for tiling works on both the floor and walls. It is an essential element for oversize and heavy tile setting works.



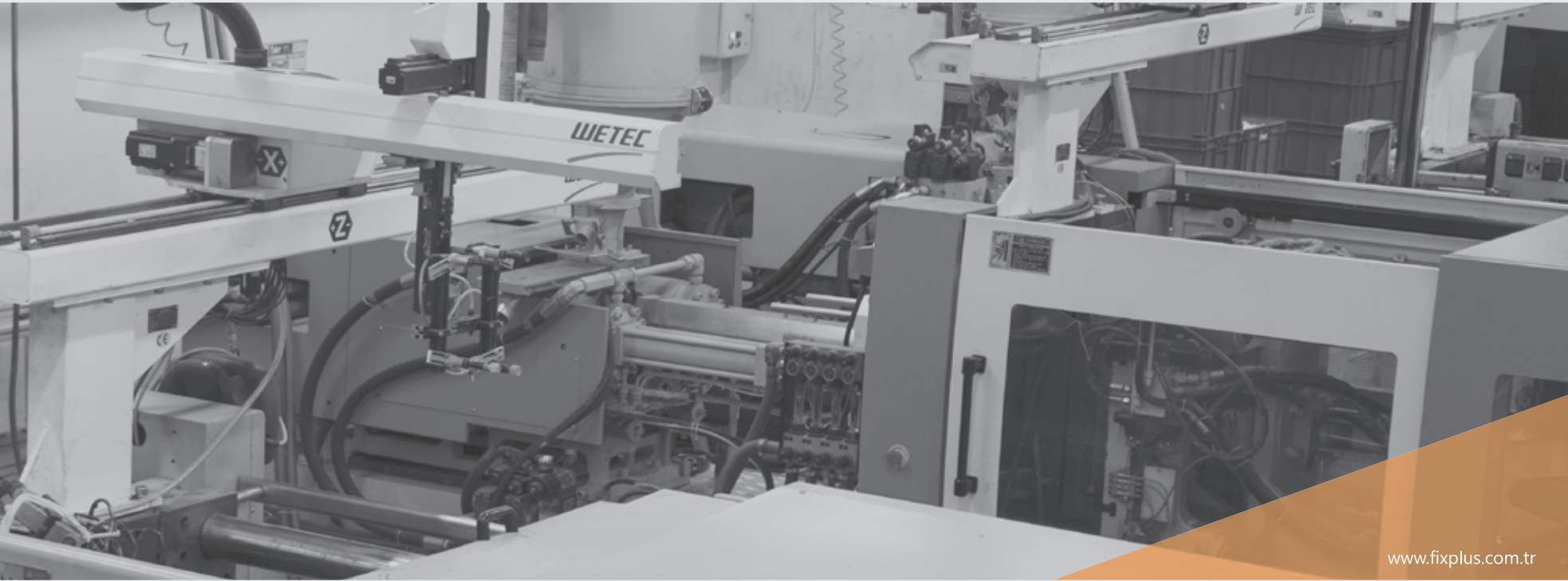

www.fixplus.com.tr



SPACER CLIPS
WEDGE
WEDGE SEPERATOR
FUNCTIONAL CROSS SPACER
PLIERS
APPLICATION





LEVELLING SYSTEM

FIXPLUS WEDGE

Classic Type of Wedge and Spacer Clip

FIXPLUS WEDGE

Fixplus 'wedge', is a classic type of levelling system which consists of wedge and spacer clip.

The system is applied manually. For laying a tile at same level the final crimping process is made by using its special plier.

That is practical and easily applicable.

To obtain different grout joint width the system has spacer clips from 1 mm to 4 mm.

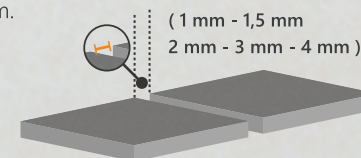

SPACER CLIPS

| | Code | Product | mm (in) | Units (per bag) | Bag (per box) | Box (cm) | Weight (kg) |
|---|-------------------------------------|-------------|---------------|--------------------|---|---|---|
| | | | | |  |  |  |
| | 1 mm Spacer Clip (3/65") | | | | | | |
|  | TT100-1 | Spacer Clip | 1 (3/64") | 100 | 20 | 40x30x41 | 7,00 |
| | TT250-1 | Spacer Clip | 1 (3/64") | 250 | 8 | 40x30x41 | 6,93 |
| | TT500-1 | Spacer Clip | 1 (3/64") | 500 | 4 | 40x30x41 | 6,90 |
| | TT2000-1 | Spacer Clip | 1 (3/64") | 2000 | - | 40x30x41 | 6,68 |
| | 1,5 mm Spacer Clip (1/16") | | | | | | |
|  | TT100-1,5 | Spacer Clip | 1,5 (1/16") | 100 | 20 | 40x30x41 | 7,00 |
| | TT250-1,5 | Spacer Clip | 1,5 (1/16") | 250 | 8 | 40x30x41 | 6,95 |
| | TT500-1,5 | Spacer Clip | 1,5 (1/16") | 500 | 4 | 40x30x41 | 6,90 |
| | TT2000-1,5 | Spacer Clip | 1,5 (1/16") | 2000 | - | 40x30x41 | 6,70 |
| | 2 mm Spacer Clip (5/64") | | | | | | |
|  | TT100-2 | Spacer Clip | 2 (5/64") | 100 | 20 | 40x30x41 | 7,70 |
| | TT250-2 | Spacer Clip | 2 (5/64") | 250 | 8 | 40x30x41 | 7,55 |
| | TT500-2 | Spacer Clip | 2 (5/64") | 500 | 4 | 40x30x41 | 7,45 |
| | TT2000-2 | Spacer Clip | 2 (5/64") | 2000 | - | 40x30x41 | 7,30 |
| | 3 mm Spacer Clip (1/8") | | | | | | |
|  | TT100-3 | Spacer Clip | 3 (1/8") | 100 | 20 | 40x30x41 | 7,85 |
| | TT250-3 | Spacer Clip | 3 (1/8") | 250 | 8 | 40x30x41 | 7,80 |
| | TT500-3 | Spacer Clip | 3 (1/8") | 500 | 4 | 40x30x41 | 7,70 |
| | TT2000-3 | Spacer Clip | 3 (1/8") | 2000 | - | 40x30x41 | 7,55 |



WEDGE

| Code | Product | Units (per bag) | Bag (per box) | Box (cm) | Weight (kg) |
|--------------|---------|--------------------|------------------|-------------|----------------|
| Wedge | | | | | |
| TK100 | Wedge | 100 | 10 | 40x30x41 | 10,50 |
| TK250 | Wedge | 250 | 4 | 40x30x41 | 10,21 |
| TK1000 | Wedge | 1000 | - | 40x30x41 | 10,05 |

| Wedge (Soft) | | | | | |
|-----------------------|-------|------|----|----------|------|
| TK100-S | Wedge | 100 | 10 | 40x30x41 | 9,40 |
| TK250-S | Wedge | 250 | 4 | 40x30x41 | 9,10 |
| TK1000-S | Wedge | 1000 | - | 40x30x41 | 8,90 |

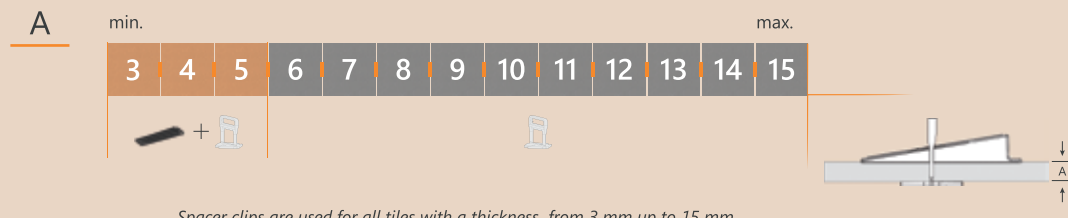

Spacer clips are used for all tiles with a thickness from 3 mm up to 15 mm.

WEDGE SEPARATOR

Wedge Separator must be used with tiles thinner than 6 mm.
 It is used by being placed under the wedge.
 Can be installed and removed easily. It is reusable.

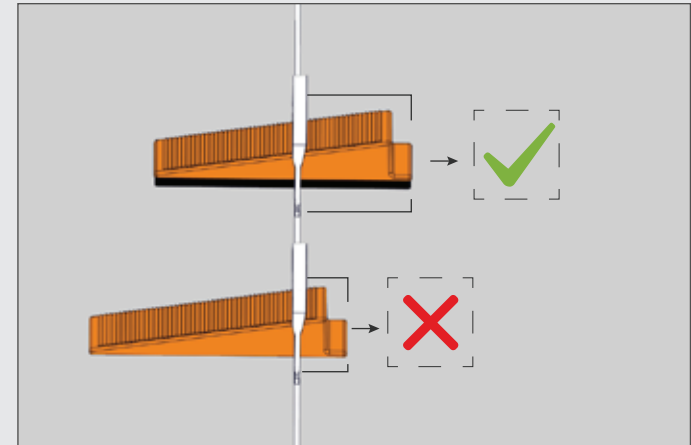

Usage of Wedge Separator.

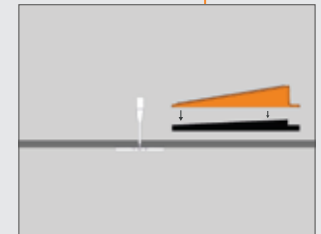
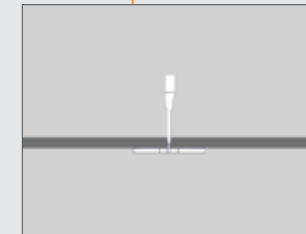

| Code | Product | Units (per bag) | Bag (per box) | Box (cm) | Weight (kg) |
|-------|-----------------|--------------------|------------------|-------------|----------------|
| WP-04 | Wedge Separator | 250 | 20 | 40x30x41 | 9 |

A

min.

max.

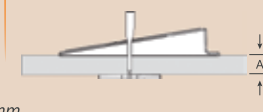

Spacer clips are used for all tiles with a thickness from 3 mm up to 15 mm.



FUNCTIONAL CROSS SPACER

- Made from quality and unbreakable material
- Can be used in three different ways of installation ' — (straight) ', ' T (brick) ' and ' + (cross) '
- They do not cause any damage on application surface during removing process
- They are appropriate for grout width ranging from 1 mm, 2 mm and 3 mm
- They are reusable.

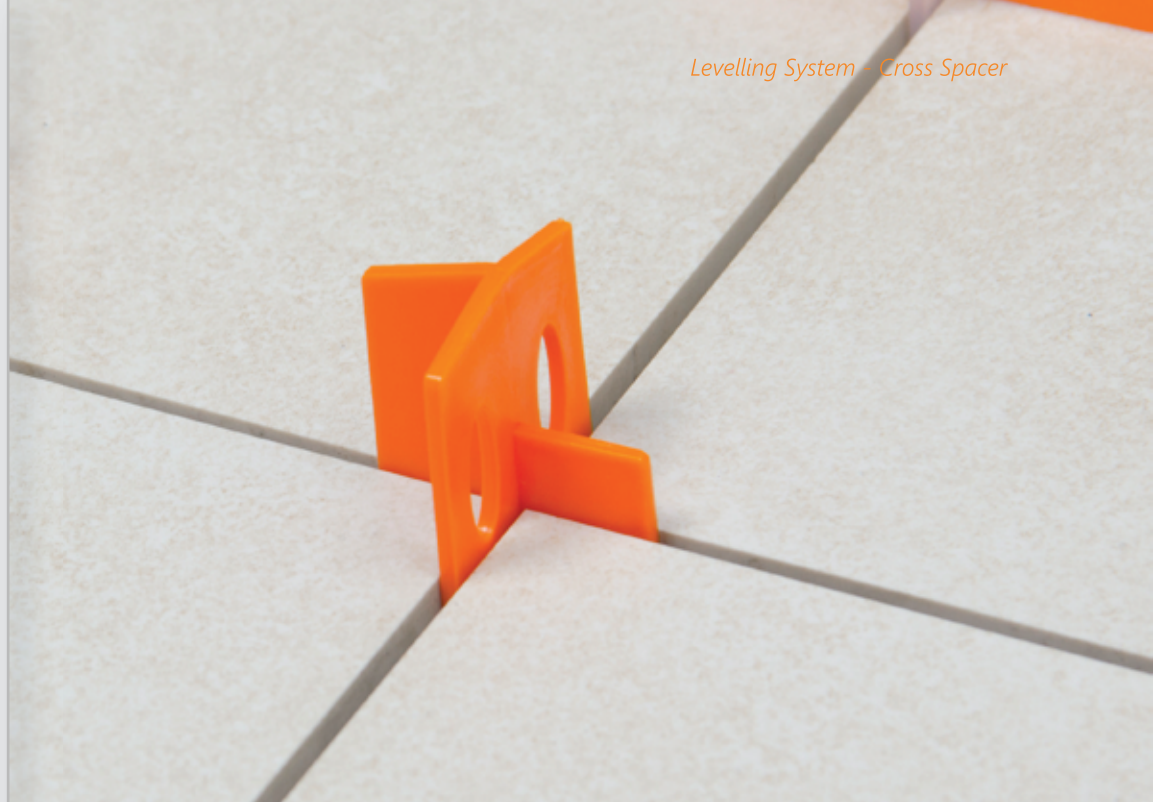

CROSS SPACER



| Code | Product | mm (in) | Units (per bag) | Bag (per box) | Box (cm) | Weight (kg) |
|---------------------------------|--------------|-------------|-----------------|---|---|---|
| 1 mm Cross Spacer (in) | | | |  |  |  |
| CT100-1 | Cross Spacer | 1 (3/64") | 100 | 10 | 40x30x24 | 2,25 |
| CT250-1 | Cross Spacer | 1 (3/64") | 250 | 4 | 40x30x24 | 2,20 |
| 2 mm Cross Spacer (in) | | | | | | |
| CT100-2 | Cross Spacer | 2 (5/64") | 100 | 10 | 40x30x24 | 3,41 |
| CT250-2 | Cross Spacer | 2 (5/64") | 250 | 4 | 40x30x24 | 3,35 |
| 3 mm Cross Spacer (in) | | | | | | |
| CT100-3 | Cross Spacer | 3 (1/8") | 100 | 10 | 40x30x24 | 4,83 |
| CT250-3 | Cross Spacer | 3 (1/8") | 250 | 4 | 40x30x24 | 4,78 |



PLASTIC PLIER

The Plastic Plier has been developed not only for amateurs who use FixPlus Levelling System and also for beginners who wish to try that.

Can be used for tiling works on both the floor and walls.

It is resistant to breakage due to its hardened raw material



| Code | Product | Unit Weight (kg) | Bag (per box) | Box (cm) | Weight (kg) |
|------|---------------|---------------------|------------------|-------------|----------------|
| FP2 | Plastic Plier | 0,24 | 50 | 40x30x41 | 14,20 |

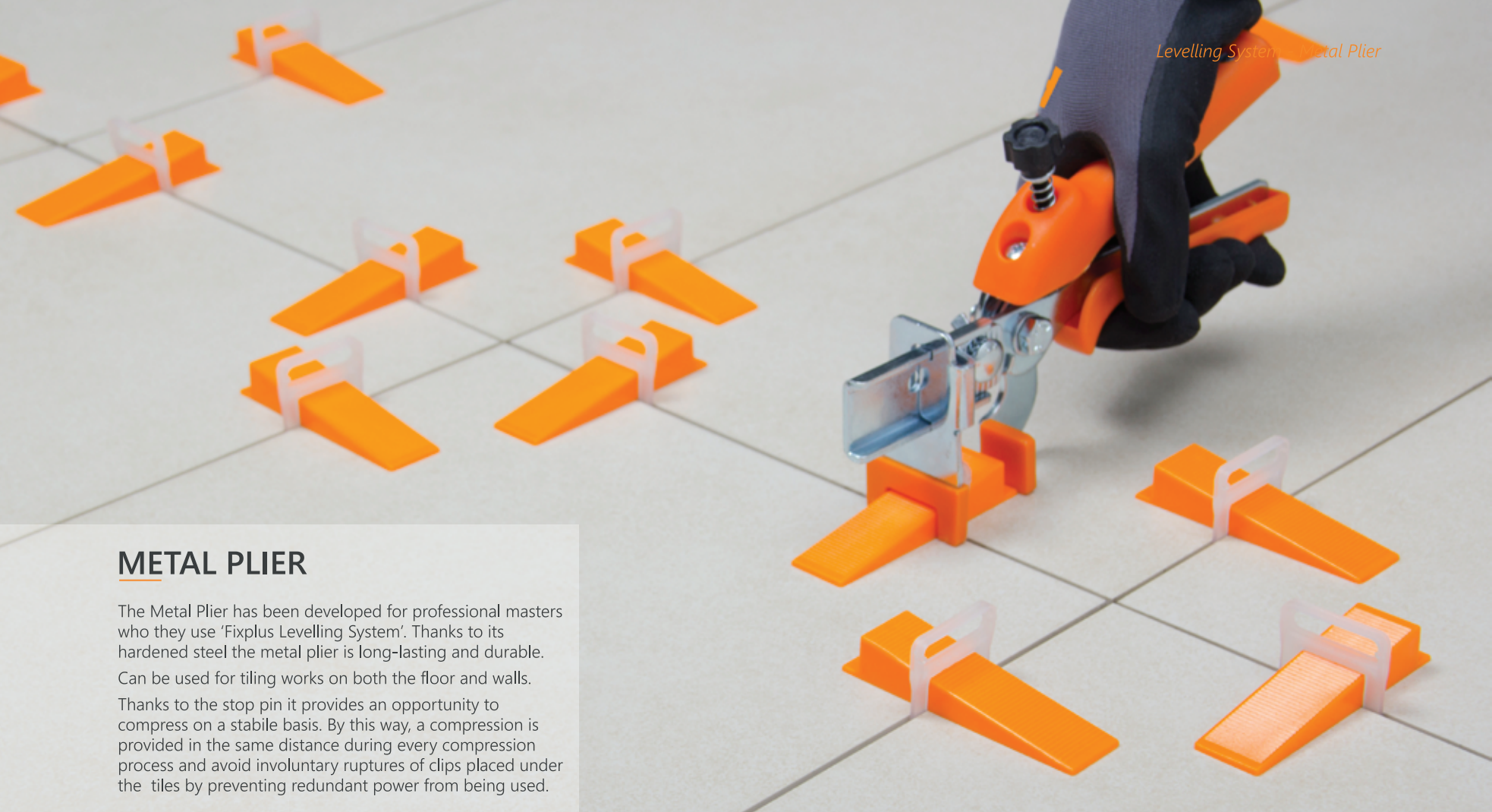

METAL PLIER

The Metal Plier has been developed for professional masters who they use 'Fixplus Levelling System'. Thanks to its hardened steel the metal plier is long-lasting and durable. Can be used for tiling works on both the floor and walls.

Thanks to the stop pin it provides an opportunity to compress on a stable basis. By this way, a compression is provided in the same distance during every compression process and avoid involuntary ruptures of clips placed under the tiles by preventing redundant power from being used.



| Code | Product | Unit Weight (kg) | Bag (per box) | Box (cm) | Weight (kg) |
|------|-------------|------------------|---------------|----------|-------------|
| FP1 | Metal Plier | 0,40 | 50 | 40x30x41 | 21,30 |

HOW TO APPLY ?



Place the clips to underneath the wedges of the tile with their flat faces equal to the ground.



Insert the wedges into clips' socket manually.



Levelling operation is completed by compressing the wedges through adjustable plier.



After levelling operation, the tile sides must be beaten slightly in parallel to the ground to take up air gap in grout between edges.

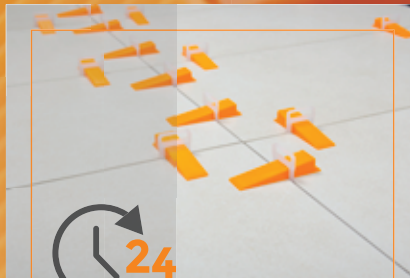

Wait till the end of a required drying period after application.



Once the adhesive is set , remove the wedges and clips by beating them from their sides.

After removal procedure the retained wedges must be kept to use in next work.



BEFORE

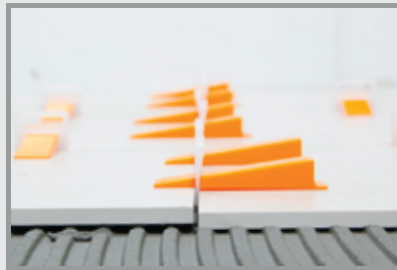

AFTER

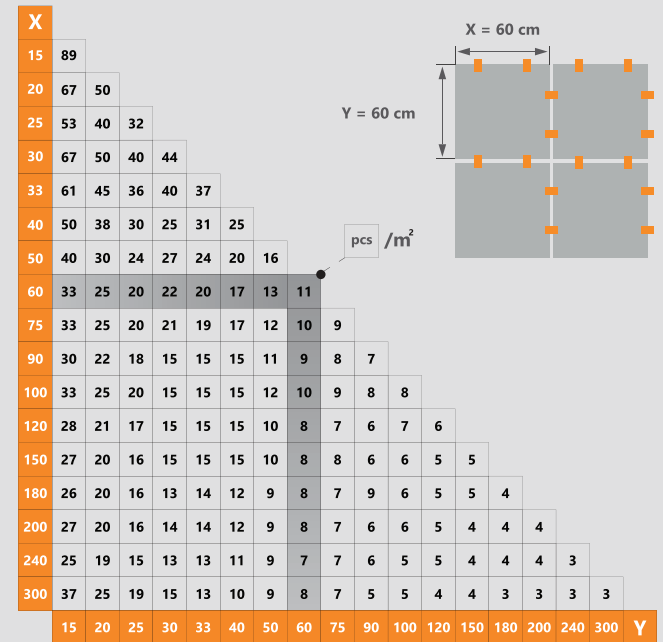

" Use the chart how to calculate quantities of materials "

Fixplus Levelling System, ensures tiles to be set at same level. During a tiling work, it helps to avoid installation mistakes arising from surface deformations and also accelerate process.



SCREW CAP
SCREW CLIPS
APPLICATION



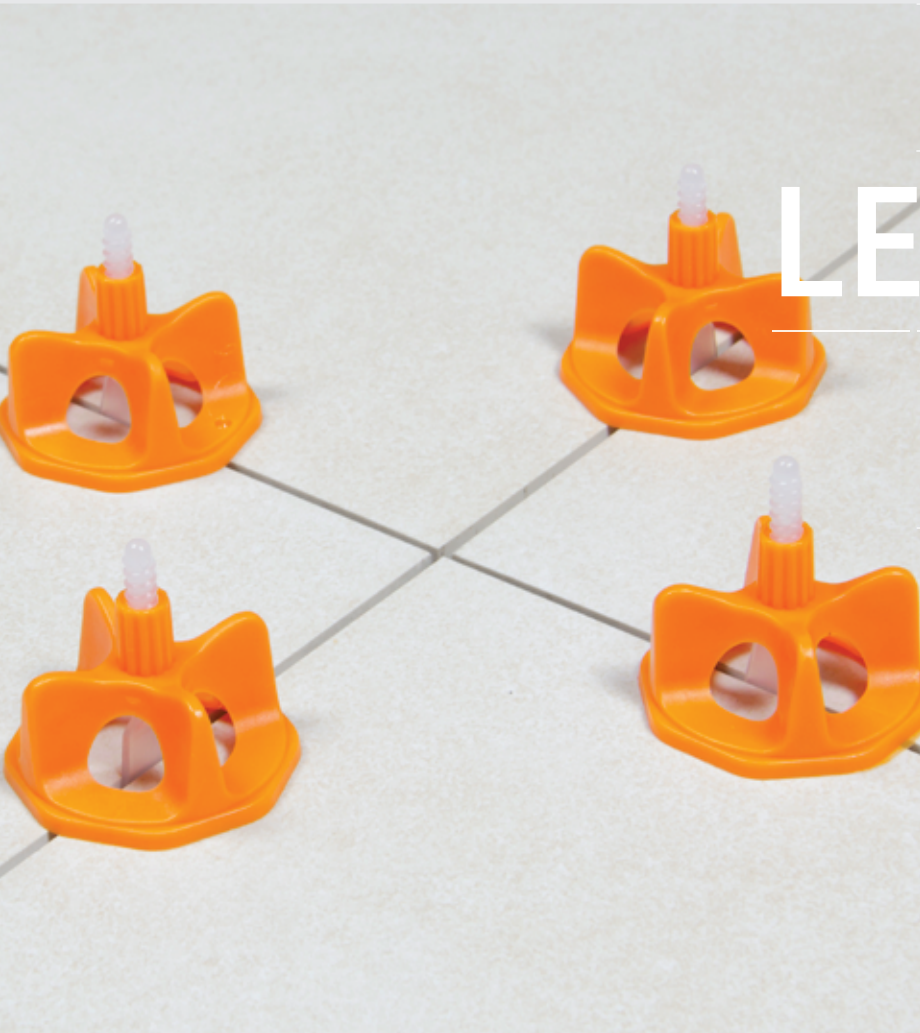

LEVELLING SYSTEM

FIXPLUS SCREW

Screw Cap and Screw Clip

FIXPLUS SCREW

Fixplus Screw is a levelling system which consists of screw cap and screw clip.

It is applied manually and not required a crimping plier.





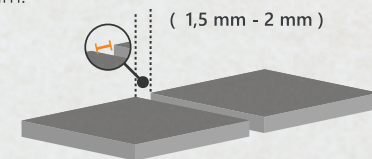

Screw cap has a reusable design and also suitable for both of the clips.

Can be used for tiling on both wall and floor.

It has clips in grout dimension 1,5 mm and 2 mm.



SCREW CAP - SCREW CLIP

| | Code | Product | mm (in) | Units (per bag) | Bag (per box) | Box (cm) | Weight (kg) |
|--|------------------------------------|--------------------------|--------------------------------|--------------------|---|---|---|
|  | 1,5 mm Screw Clip (1/16") | | | |  |  |  |
| | SC250-1,5 SC2500-1,5 | Screw Clip Screw Clip | 1,5 (1/16") 1,5 (1/16") | 250 2500 | 10 - | 40x30x41 40x30x41 | 7,45 7,10 |
|  | 2 mm Screw Clip (5/64") | | | | | | |
| | SC250-2 SC2500-2 | Screw Clip Screw Clip | 2 (5/64") 2 (5/64") | 250 2500 | 10 - | 40x30x41 40x30x41 | 7,80 7,25 |
|  | Screw Cap | | | | | | |
| | SW100 SW600 | Screw Cap Screw Cap | - - | 100 600 | 6 - | 40x30x41 40x30x41 | 6,80 6,60 |

A

min.



max.

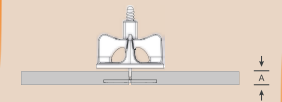

Screw Clips are used for all tiles with a thickness from 3 mm up to 20 mm.

HOW TO APPLY ?



Place the screw clips to tile edges with their flat faces equal to the base.



Insert the screw cap in the clips' screw. By only using your fingers, twist the screw cap down with a single action.



Twist the screw cap down to the end to level the tile edges.



Wait till the end of a required drying period after application.



Once the adhesive is set, remove the screw caps and clips by beating from side.



Removed screw caps can be used again by separating them from wasting parts of screw clips.

After removal procedure the retained screw caps must be kept to use in next work.

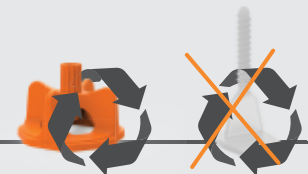

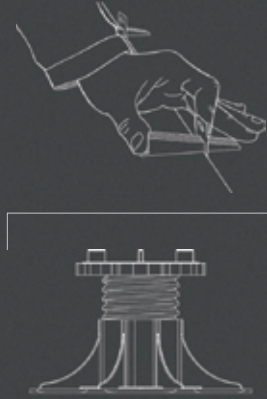

ÖZTÜRK PLASTİK ve KALIP SAN. TİC. LTD. ŞTİ.

İkitelli Organize Sanayi Bölgesi Mah. Enkoop Cad.

No: 4 / C Başakşehir / İstanbul - TÜRKİYE

Tlf: +90 212 485 24 53 Fax: +90 212 485 24 21

www.ozturkplastik.com - info@fixplus.com.tr

CERTIFICAZIONE
DI PRODOTTO
BUREAU VERITAS
Certification

N° TR006326-1

